

7 mm Specifications to IEC 457-2

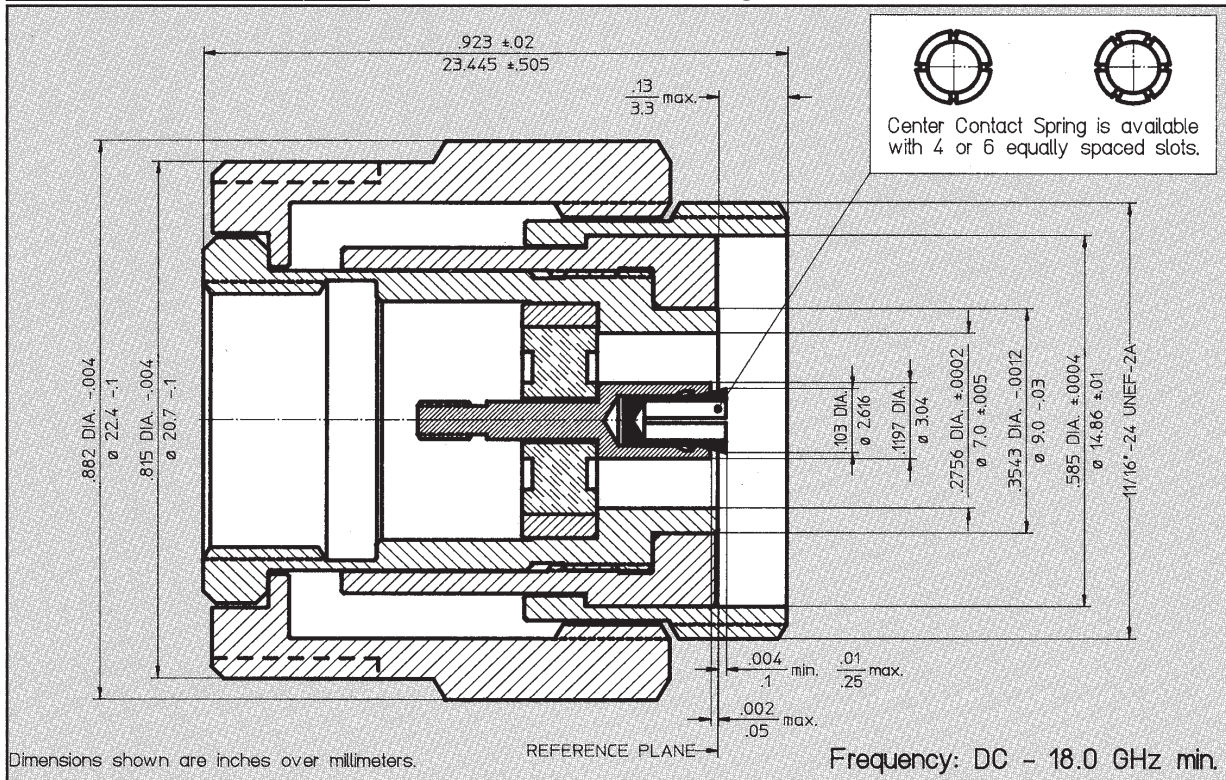

The specifications below are general specifications for all 7 mm connectors. Specific Data for VSWR, Insertion Loss, R.F. leakage, etc., are available from the factory upon request. Specifications in the following table are recommended for any procurement documents or drawings. In the event of any conflict between these specifications and General Specifications IEC 457-2, these specifications shall govern. These specifications are subject to change according to the latest revision.

REQUIREMENT	GENERAL SPECIFICATIONS
GENERAL	
Standard Materials	STEEL corrosion resistant 1.4305 per DIN 17440 (QQ-S-764, class 303 or ASTM-A-582-80). ALUMINUM AlMg4.5Mn per DIN 1725, AlMgSi0.5 per DIN 1725, AlMgSi1 per DIN 1725 (6061-T6 per QQ-A-225/8). BRASS CuZn39Pb3 per DIN 17660 (QQ-B-626, half hard). COPPER BERYLLIUM 33-25 CuBe2Pb H per DIN 17666 (QQ-C-530). TFE Fluorocarbon per DIN 52900 (MIL-P-19468 and L-P403). SILICONE RUBBER per DIN 3771 (MIL-R-5847 and ZZ-R-765, Class II B,) Grade 50 - 75. BORRIUM NITRITE Dielectric for high power applications per inhouse specification.
Finish for COPPER BERYLLIUM	Center Contacts shall be gold plated to a minimum thickness of .00005 inch (1.27 µm) in accordance with MIL-G-45204, Type II, Grade C.
STAINLESS STEEL	shall be passivated per QQ-P-35.
ALUMINUM	Conductive Parts shall have an iridited finish per MIL-C-5541.
BRASS	Other parts, such as Coupling Nuts and Back-Bodies shall be anodized per MIL-A-8625. .00003 inch (0.8 µm) min. gold plating per MIL-G-45204, or nicle plating per QQ-N-290, as specified.
VARIOUS	Imoloy .0001 inch (2.5 µm) min. plating, consisting of 55% Copper / 20% Zinc / 25% Tin (on special request).
Design	The design shall be such that the outline dimensions in this catalog are met. In addition, the assembled connector shall meet the interface dimensions.
ELECTRICAL	
Frequency Range	DC - 18.0 GHz min.
Insulation Resistance	The insulation resistance is not applicable.
Voltage Standing Wave Ratio (VSWR)	1.003 + .002 * f (GHz)
Contact Resistance	The center contact resistance drop shall not exceed 1.0 milliohms and the outer contact resistance drop shall not exceed 0.1 milliohms.
Dielectric Withstanding Voltage	The magnitude of the test voltage shall be 2,500 volts rms at sea level.
RF High Potential Withstanding Voltage	The RF high potential withstanding voltage is 1,000 volts rms at 5 MHz. Leakage is not applicable.
RF Leakage	-(120 - f (GHz)) dB
Insertion Loss	(.007 SQT(f(GHz))) dB
MECHANICAL	
Connector Durability	The connector is to be tested and its mating connector shall be subjected to 5000 insertions. Withdrawal cycles not applicable. The connector shall show no evidence of mechanical failure and the connector shall meet the mating characteristic requirements.
Cable Retention Force	Cable Retention Force is not applicable.
Coupling Nut Retention Force	Coupling Nut Retention Force is not applicable.
Force to Engage and Disengage	Force to Engage and Disengage is not applicable.
Longitudinal Force max.	Longitudinal force is not applicable.
Mating Characteristics	Mating Characteristics are not applicable.
Recommended Mating Torque	16 - 29 inch-pounds (1.8 - 3.3 Nm)
ENVIRONMENTAL	
Corrosion (Salt Spray)	Specification MIL-STD-202, Method 101, Test Condition B. The salt solution shall be 5%.
Vibration	Specification MIL-STD-202, Method 204, Test Condition B.
Shock	Specification MIL-STD-202, Method 213, Test Condition I.
Thermal Shock	Specification MIL-STD-202, Method 107, Test Condition B, except high temperature shall be + 200°C.
Moisture Resistance	Specification MIL-STD-202, Method 106. Step 7b (vibration) shall be omitted. Insulation resistance shall be 200 megohms min. within 5 minutes of removal from humidity.
Corona Level	Corona Level is not applicable.



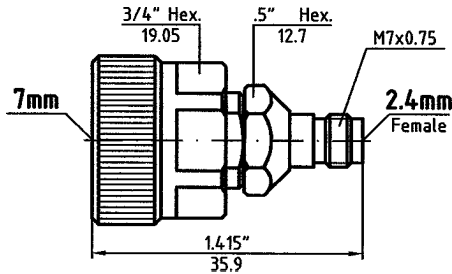

The Center Conductor of the 7 mm Connector is supplied with 4 slots. If you require 6 slots, Part Number changes to: **8001 - HF96 - 02**

Part - No.	8001-HF90-02
Connectors	2.4mm-F to 7mm
Frequency	DC - 18.0 GHz
VSWR max.	1.06 : 1

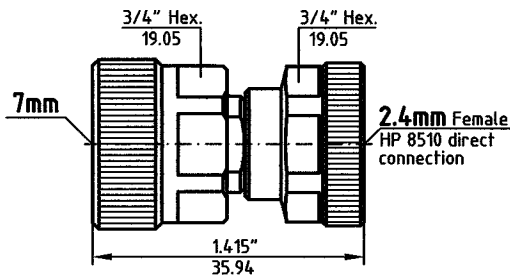

The Center Conductor of the 7 mm Connector is supplied with 4 slots. If you require 6 slots, Part Number changes to: **8001 - H296 - 02**

Part - No.	8001-H290-02
Connectors	2.4mm-F to 7mm
Frequency	DC - 18.0 GHz
VSWR max.	1.06 : 1

for direct connection with HP8510

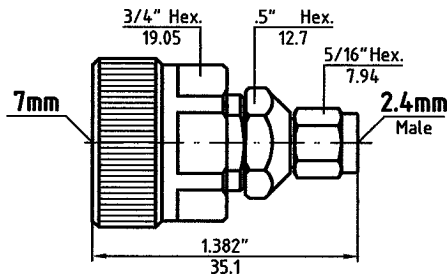

The Center Conductor of the 7 mm Connector is supplied with 4 slots. If you require 6 slots, Part Number changes to: **8001 - HM96 - 02**

Part - No.	8001-HM90-02
Connectors	2.4mm-M to 7mm
Frequency	DC - 18.0 GHz
VSWR max.	1.06 : 1

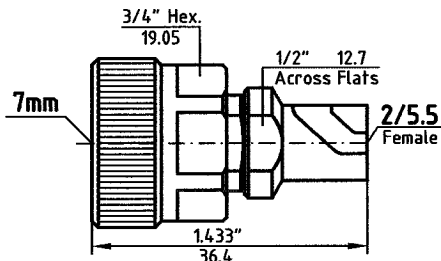

The Center Conductor of the 7 mm Connector is supplied with 4 slots. If you require 6 slots, Part Number changes to: **8001 - F296 - 02**

Part - No.	8001-F290-02
Connectors	2/5.5-F to 7mm
Frequency	DC - 14.0 GHz
VSWR max.	1.06 + 0.01 x f (GHz)

F7mmh1.jpg

Dimensions shown are inches over millimeters. Standard units have stainless steel finish (last two digits of the P/N are -02). Interfaces are per MIL-C 39012, MIL-C-87104/2, MIL-C-3643, MIL-STD-348, IEC-169-7, IEC-457-2, DIN 47 223, DIN 47 226, DIN 47 298, where applicable. For details please refer to the beginning of this section.

Between-Series Adapters to Type 7 mm

The Center Conductor of the 7 mm Connector is supplied with 4 slots. If you require 6 slots, Part Number changes to: **8001 - 9296 - 02**

Part - No.	8001-9092-02
Connectors	3.5mm-F to 7mm
Frequency	DC - 18.0 GHz
VSWR max.	1.15 : 1

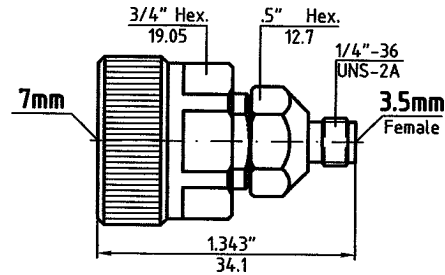

The Center Conductor of the 7 mm Connector is supplied with 4 slots. If you require 6 slots, Part Number changes to: **8002 - 9296 - 02**

Part - No.	8002-9092-02
Connectors	3.5mm-F to 7mm
Frequency	DC - 18.0 GHz
VSWR max.	1.06 : 1

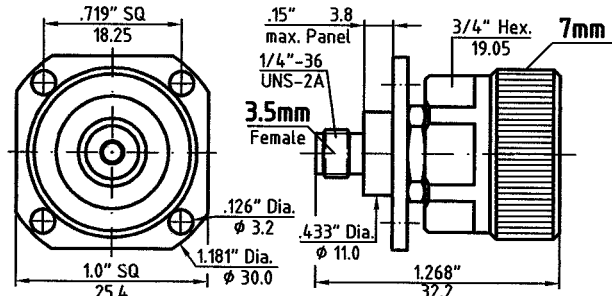

The Center Conductor of the 7 mm Connector is supplied with 4 slots. If you require 6 slots, Part Number changes to: **8003 - 9296 - 02**

Part - No.	8003-9092-02
Connectors	3.5mm-F to 7mm
Frequency	DC - 18.0 GHz
VSWR max.	1.06 : 1

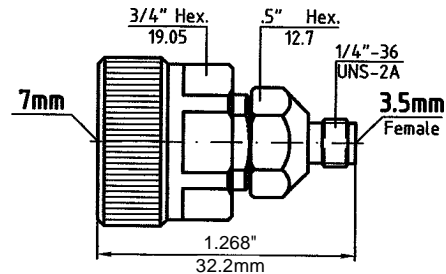

The Center Conductor of the 7 mm Connector is supplied with 4 slots. If you require 6 slots, Part Number changes to: **8001 - H396 - 02**

Part - No.	8001-H390-02
Connectors	3.5mm-F to 7mm
Frequency	DC - 18.0 GHz
VSWR max.	1.06 : 1

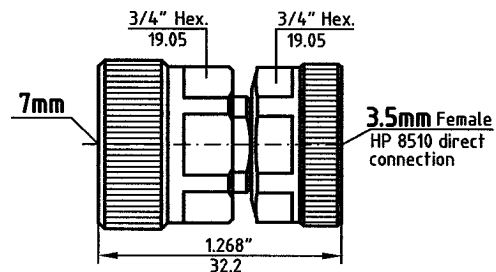

for direct connection with HP8510

Dimensions shown are inches over millimeters. Standard units have stainless steel finish (last two digits of the P/N are -02). Interfaces are per MIL-C 39012, MIL-C-87104/2, MIL-C-3643, MIL-STD-348, IEC-169-7, IEC-457-2, DIN 47 223, DIN 47 226, DIN 47 298, where applicable. For details please refer to the beginning of this section.



Between-Series Adapters to Type 7 mm

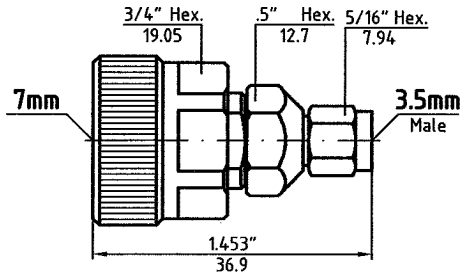

The Center Conductor of the 7 mm Connector is supplied with 4 slots. If you require 6 slots, Part Number changes to: **8001 - 9196 - 02**

Part - No.	8001-9091-02
Connectors	3.5mm-M to 7mm
Frequency	DC - 18.0 GHz
VSWR max.	1.15 : 1

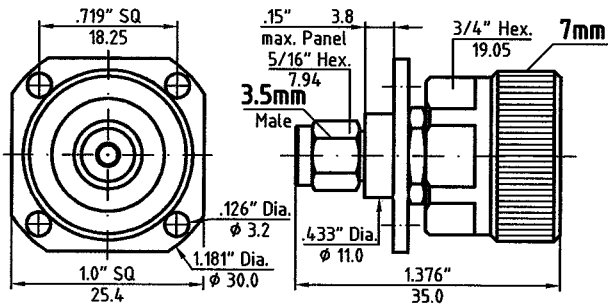

The Center Conductor of the 7 mm Connector is supplied with 4 slots. If you require 6 slots, Part Number changes to: **8002 - 9196 - 02**

Part - No.	8002-9091-02
Connectors	3.5mm-M to 7mm
Frequency	DC - 18.0 GHz
VSWR max.	1.06 : 1

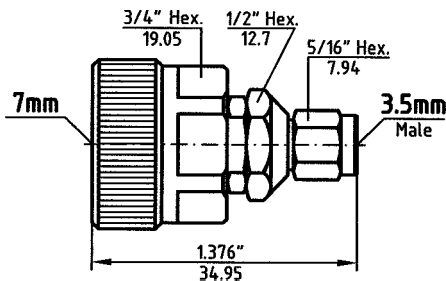

The Center Conductor of the 7 mm Connector is supplied with 4 slots. If you require 6 slots, Part Number changes to: **8003 - 9196 - 02**

Part - No.	8003-9091-02
Connectors	3.5mm-M to 7mm
Frequency	DC - 18.0 GHz
VSWR max.	1.06 : 1

F7mmh1.ppt5

Dimensions shown are inches over millimeters. Standard units have stainless steel finish (last two digits of the P/N are -02). Interfaces are per MIL-C 39012, MIL-C-87104/2, MIL-C-3643, MIL-STD-348, IEC-169-7, IEC-457-2, DIN 47 223, DIN 47 226, DIN 47 298, where applicable. For details please refer to the beginning of this section.

Between-Series Adapters to Type 7 mm



The Center Conductor of the 7 mm Connector is supplied with 4 slots. If you require 6 slots, Part Number changes to: **8001 - 8996 - 02**

Part - No.	8001- 8990 - 02
Connectors	C-Female to 7mm
Frequency	DC - 10.0 GHz
VSWR max.	1.06 + 0.01 x f (GHz)

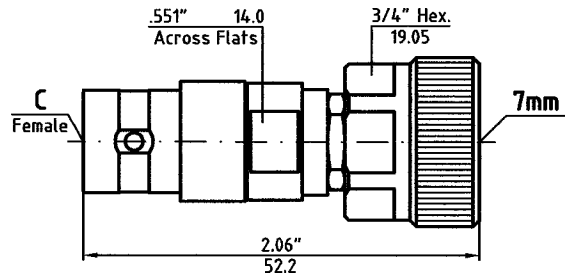

The Center Conductor of the 7 mm Connector is supplied with 4 slots. If you require 6 slots, Part Number changes to: **8001 - 8896 - 02**

Part - No.	8001- 8890 - 02
Connectors	C-Male to 7mm
Frequency	DC - 10.0 GHz
VSWR max.	1.06 + 0.01 x f (GHz)

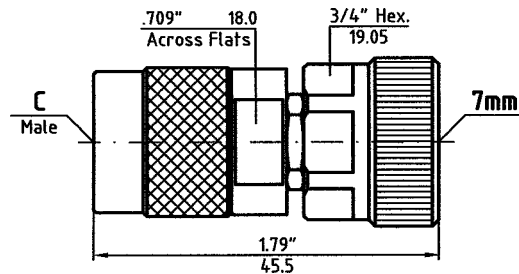

The Center Conductor of the 7 mm Connector is supplied with 4 slots. If you require 6 slots, Part Number changes to: **8001 - 7996 - 02**

Part - No.	8001- 7990 - 02
Connectors	SC-Female to 7mm
Frequency	DC - 10.0 GHz
VSWR max.	1.06 + 0.01 x f (GHz)

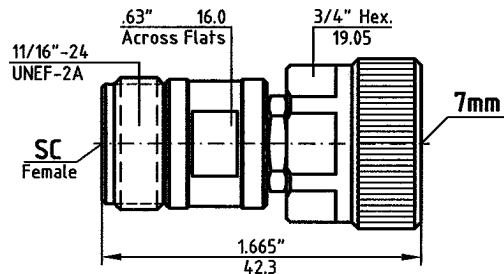

The Center Conductor of the 7 mm Connector is supplied with 4 slots. If you require 6 slots, Part Number changes to: **8001 - 8096 - 02**

Part - No.	8001- 8090 - 02
Connectors	SC-Male to 7mm
Frequency	DC - 10.0 GHz
VSWR max.	1.06 + 0.01 x f (GHz)

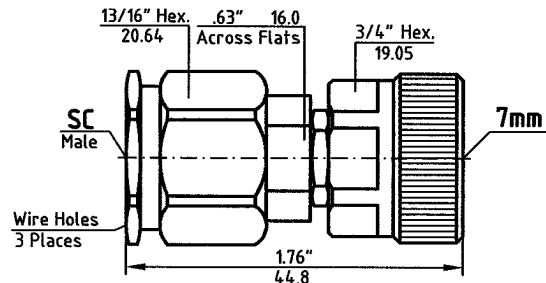

Dimensions shown are inches over millimeters. Standard units have stainless steel finish (last two digits of the P/N are -02). Interfaces are per MIL-C 39012, MIL-C-87104/2, MIL-C-3643, MIL-STD-348, IEC-169-7, IEC-457-2, DIN 47 223, DIN 47 226, DIN 47 298, where applicable. For details please refer to the beginning of this section.

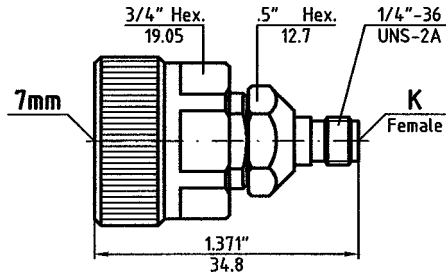

The Center Conductor of the 7 mm Connector is supplied with 4 slots. If you require 6 slots, Part Number changes to: **8001 - KF96 - 02**

Part - No.	8001-KF90-02
Connectors	K*-Female to 7mm
Frequency	DC - 18.0 GHz
VSWR max.	1.06 : 1

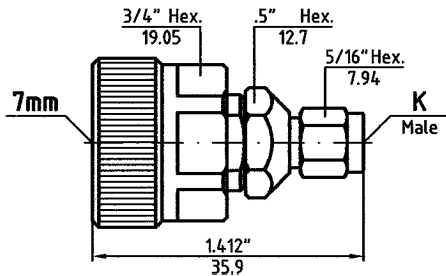

The Center Conductor of the 7 mm Connector is supplied with 4 slots. If you require 6 slots, Part Number changes to: **8001 - KM96 - 02**

Part - No.	8001-KM90-02
Connectors	K*-Male to 7mm
Frequency	DC - 18.0 GHz
VSWR max.	1.06 : 1

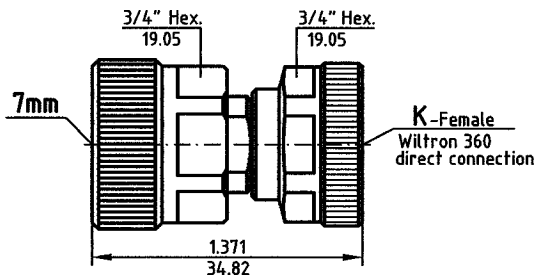

The Center Conductor of the 7 mm Connector is supplied with 4 slots. If you require 6 slots, Part Number changes to: **8001 - WI96 - 02**

Part - No.	8001-WI90-02
Connectors	K*-Female to 7mm
Frequency	DC - 18.0 GHz
VSWR max.	1.06 : 1

for direct connection with Wiltron 360

F7mmh1.ppt5

Dimensions shown are inches over millimeters. Standard units have stainless steel finish (last two digits of the P/N are -02). Interfaces are per MIL-C 39012, MIL-C-87104/2, MIL-C-3643, MIL-STD-348, IEC-169-7, IEC-457-2, DIN 47 223, DIN 47 226, DIN 47 298, where applicable. For details please refer to the beginning of this section.

* 'K' Connector is a trademark of Wiltron Company

Between-Series Adapters to Type 7 mm



The Center Conductor of the 7 mm Connector is supplied with 4 slots. If you require 6 slots, Part Number changes to: **8001 - 6196 - 02**

Part - No.	8001 - 6190 - 02
Connectors	N-Female to 7mm
Frequency	DC - 18.0 GHz
VSWR max.	1.06 : 1

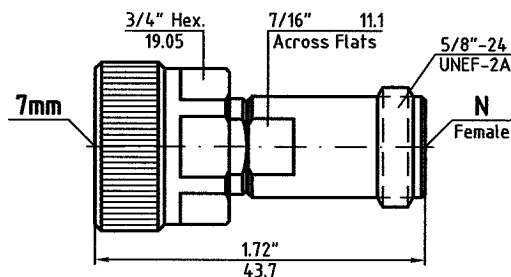

The Center Conductor of the 7 mm Connector is supplied with 4 slots. If you require 6 slots, Part Number changes to: **8002 - 6196 - 02**

Part - No.	8002 - 6190 - 02
Connectors	N-Female to 7mm
Frequency	DC - 18.0 GHz
VSWR max.	1.06 : 1

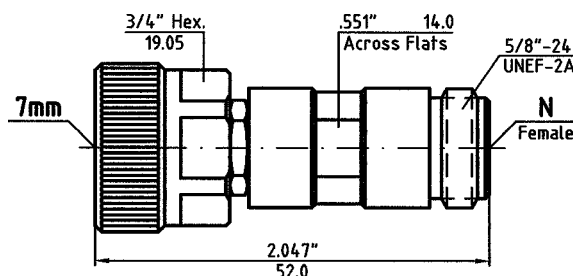

The Center Conductor of the 7 mm Connector is supplied with 4 slots. If you require 6 slots, Part Number changes to: **8001 - 5196 - 02**

Part - No.	8001 - 5190 - 02
Connectors	N-Male to 7mm
Frequency	DC - 18.0 GHz
VSWR max.	1.06 : 1

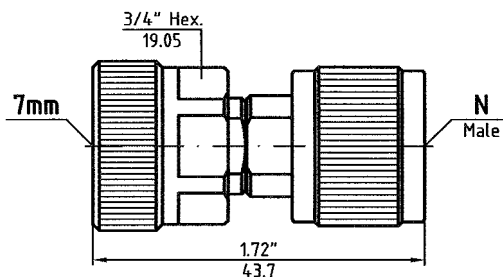

The Center Conductor of the 7 mm Connector is supplied with 4 slots. If you require 6 slots, Part Number changes to: **8002 - 5196 - 02**

Part - No.	8002 - 5190 - 02
Connectors	N-Male to 7mm
Frequency	DC - 18.0 GHz
VSWR max.	1.06 : 1

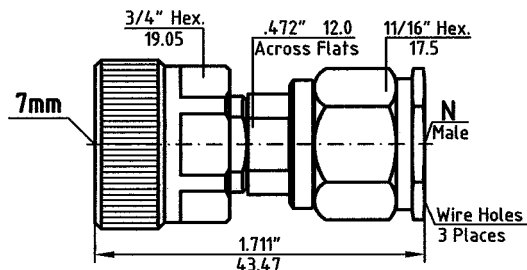

Dimensions shown are inches over millimeters. Standard units have stainless steel finish (last two digits of the P/N are -02). Interfaces are per MIL-C 39012, MIL-C-87104/2, MIL-C-3643, MIL-STD-348, IEC-169-7, IEC-457-2, DIN 47 223, DIN 47 226, DIN 47 298, where applicable. For details please refer to the beginning of this section.

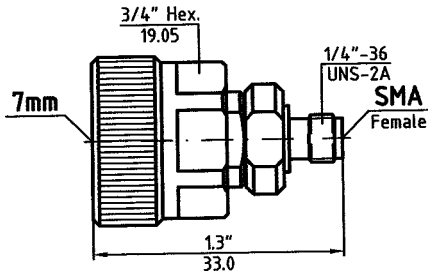

The Center Conductor of the 7 mm Connector is supplied with 4 slots. If you require 6 slots, Part Number changes to: **8001 - 2196 - 02**

Part - No.	8001-2190-02
Connectors	SMA-F to 7mm
Frequency	DC - 18.0 GHz
VSWR max.	1.06 : 1

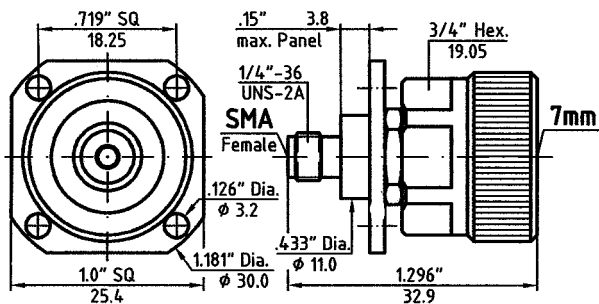

The Center Conductor of the 7 mm Connector is supplied with 4 slots. If you require 6 slots, Part Number changes to: **8002 - 2196 - 02**

Part - No.	8002-2190-02
Connectors	SMA-F to 7mm
Frequency	DC - 18.0 GHz
VSWR max.	1.06 : 1

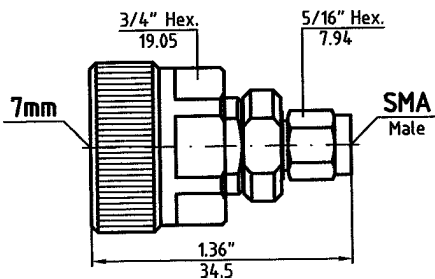

The Center Conductor of the 7 mm Connector is supplied with 4 slots. If you require 6 slots, Part Number changes to: **8001 - 1196 - 02**

Part - No.	8001-1190-02
Connectors	SMA-M to 7mm
Frequency	DC - 18.0 GHz
VSWR max.	1.06 : 1

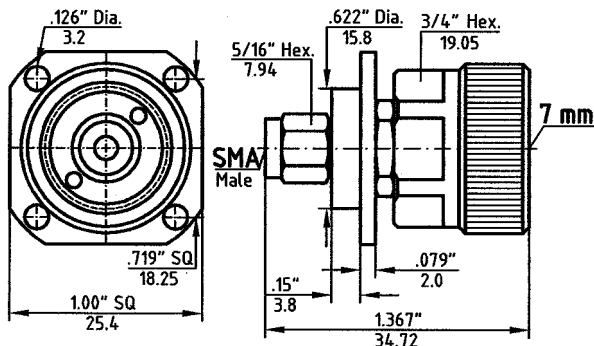

The Center Conductor of the 7 mm Connector is supplied with 4 slots. If you require 6 slots, Part Number changes to: **8002 - 1196 - 02**

Part - No.	8002-1190-02
Connectors	SMA-M to 7mm
Frequency	DC - 18.0 GHz
VSWR max.	1.06 : 1

F7mmh1.jpg

Dimensions shown are inches over millimeters. Standard units have stainless steel finish (last two digits of the P/N are -02). Interfaces are per MIL-C 39012, MIL-C-87104/2, MIL-C-3643, MIL-STD-348, IEC-169-7, IEC-457-2, DIN 47 223, DIN 47 226, DIN 47 298, where applicable. For details please refer to the beginning of this section.

Between-Series Adapters to Type 7 mm

If you require 6 slots at the 7mm Center Conductor, the Part Number will become: **8001 - MP96 - 02**

Part - No.	8001-MP90-02
Connectors	SMP-F to 7mm
Frequency	DC - 18.0 GHz
VSWR max.	1.10 : 1

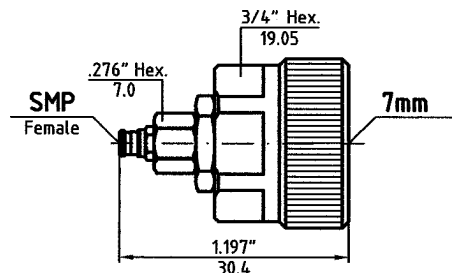

If you require 6 slots at the 7mm Center Conductor, the Part Number will become: **8001 - MJ96 - 02**

Part - No.	8001-MJ90-02
Connectors	SMP-M to 7mm
Frequency	DC - 18.0 GHz
VSWR max.	1.10 : 1

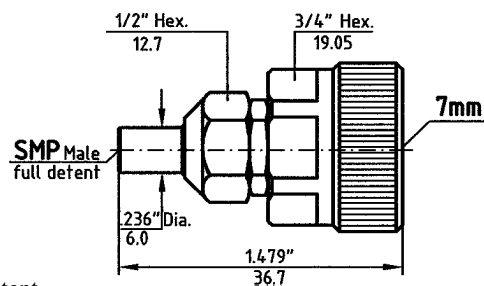

Full detent

If you require 6 slots at the 7mm Center Conductor, the Part Number will become: **8002 - MJ96 - 02**

Part - No.	8002-MJ90-02
Connectors	SMP-M to 7mm
Frequency	DC - 18.0 GHz
VSWR max.	1.10 : 1

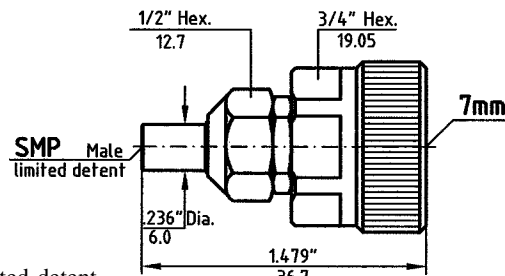

Limited detent

If you require 6 slots at the 7mm Center Conductor, the Part Number will become: **8003 - MJ96 - 02**

Part - No.	8003-MJ90-02
Connectors	SMP-M to 7mm
Frequency	DC - 18.0 GHz
VSWR max.	1.10 : 1

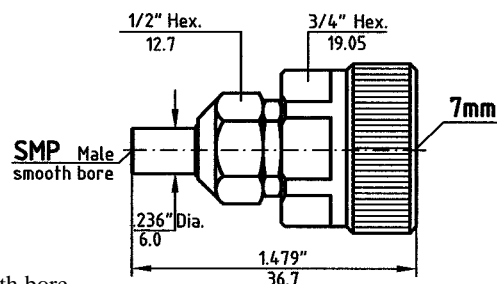

Smooth bore

If you require 6 slots at the 7mm Center Conductor, the Part Number will become: **8004 - MJ96 - 02**

Part - No.	8004-MJ90-02
Connectors	SMP-M to 7mm
Frequency	DC - 18.0 GHz
VSWR max.	1.10 : 1

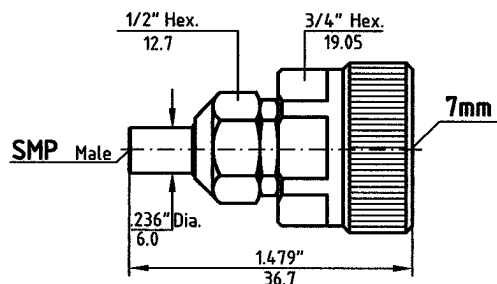

Dimensions shown are inches over millimeters. Standard units have stainless steel finish (last two digits of the P/N are -02). Interfaces are per MIL-C 39012, MIL-C-87104/2, MIL-C-3643, MIL-STD-348, IEC-169-7, IEC-457-2, DIN 47 223, DIN 47 226, DIN 47 298, where applicable. For details please refer to the beginning of this section.

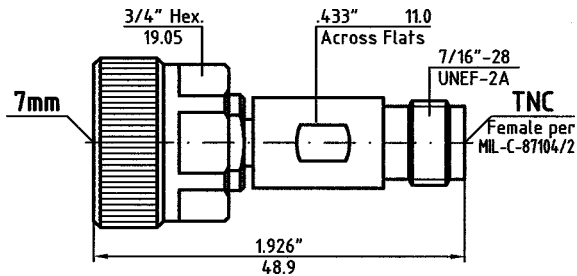

The Center Conductor of the 7 mm Connector is supplied with 4 slots. If you require 6 slots, Part Number changes to: **8002 - 4196 - 02**

Part - No.	8002-4190-02
Connectors	TNC-F to 7mm
Frequency	DC - 18.0 GHz
VSWR max.	1.10 : 1

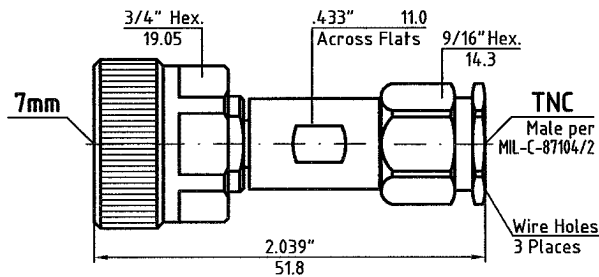

The Center Conductor of the 7 mm Connector is supplied with 4 slots. If you require 6 slots, Part Number changes to: **8002 - 3196 - 02**

Part - No.	8002-3190-02
Connectors	TNC-M to 7mm
Frequency	DC - 15.0 GHz
VSWR max.	1.10 : 1

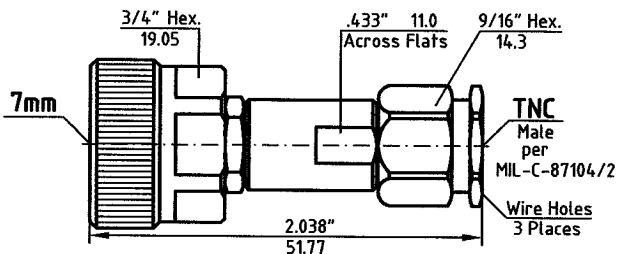

The Center Conductor of the 7 mm Connector is supplied with 4 slots. If you require 6 slots, Part Number changes to: **8003 - 3196 - 02**

Part - No.	8003-3190-02
Connectors	TNC-M to 7mm
Frequency	DC - 18.0 GHz
VSWR max.	1.10 : 1

F7mmh1.ppt5

Dimensions shown are inches over millimeters. Standard units have stainless steel finish (last two digits of the P/N are -02). Interfaces are per MIL-C 39012, MIL-C-87104/2, MIL-C-3643, MIL-STD-348, IEC-169-7, IEC-457-2, DIN 47 223, DIN 47 226, DIN 47 298, where applicable. For details please refer to the beginning of this section.

Between-Series Adapters to Type 7 mm

The Center Conductor of the 7 mm Connector is supplied with 4 slots. If you require 6 slots, Part Number changes to: **8001 - 4996 - 02**

Part - No.	8001-4990-02
Connectors	TNX-F to 7mm
Frequency	DC - 18.0 GHz
VSWR max.	1.10 : 1

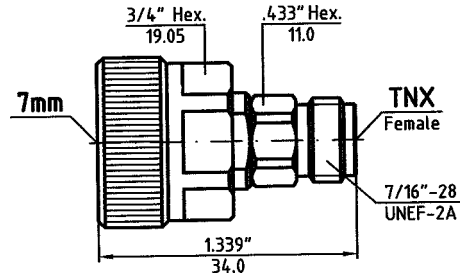

The Center Conductor of the 7 mm Connector is supplied with 4 slots. If you require 6 slots, Part Number changes to: **8001 - 3996 - 02**

Part - No.	8001-3990-02
Connectors	TNX-M to 7mm
Frequency	DC - 18.0 GHz
VSWR max.	1.10 : 1

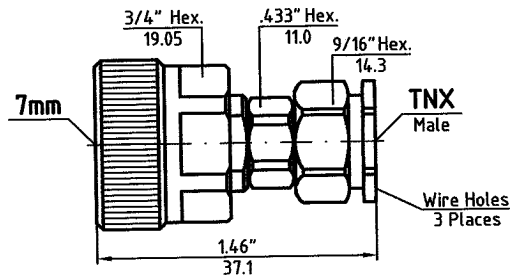

Dimensions shown are inches over millimeters. Standard units have stainless steel finish (last two digits of the P/N are -02). Interfaces are per MIL-C 39012, MIL-C-87104/2, MIL-C-3643, MIL-STD-348, IEC-169-7, IEC-457-2, DIN 47 223, DIN 47 226, DIN 47 298, where applicable. For details please refer to the beginning of this section.